







SUMMARY OF SLAT & LOUVRES

(availability & colours)

ref.		available colours	application																
50A	 <p>50 mm slat aluminium stove enamelled</p>	<p><u>standard :</u></p> <p>white white gloss aluminium/silver</p> <p><u>others at request,</u> various suppliers collections</p>	internal																
80R	 <p>80mm rollformed edges 0,45mm stove enamelled slat</p>	<p><u>standard available:</u> <u>solid & perforated</u></p> <p>white Ral 9010 silver Ral 9006</p> <p><u>at request</u></p> <table border="1"> <thead> <tr> <th>Projects</th> <th colspan="3">min 75m2</th> </tr> </thead> <tbody> <tr> <td>RAL nrs</td> <td>1003</td> <td>3011</td> <td>6005</td> </tr> <tr> <td></td> <td>7016</td> <td>7035</td> <td>7038</td> </tr> <tr> <td></td> <td>8017</td> <td>9007</td> <td>9016</td> </tr> </tbody> </table>	Projects	min 75m2			RAL nrs	1003	3011	6005		7016	7035	7038		8017	9007	9016	internal/external
Projects	min 75m2																		
RAL nrs	1003	3011	6005																
	7016	7035	7038																
	8017	9007	9016																
75E	 <p>75mm extruded aluminium</p>	<p>nat.anodised 15 my.</p> <p>RAL colours - powdercoated 60-80my</p>	external/internal																
88E	 <p>88mm extruded aluminium</p>	<p>nat.anodised 15 my.</p> <p>RAL colours - powdercoated 60-80my</p>	external/internal																

SUMMARY OF SLAT & LOUVRES (availability & colours)

		available colours	application
145E	145mm extruded aluminium	nat.anodised 15 my. RAL colours - powdercoated 60-80my	external/internal
			
138W	138 mm Western Red Cedar WRC	availability at request	external/internal
			
155E	155mm extruded aluminium	nat.anodised 15 my. RAL colours - powdercoated 60-80my	external/internal
			

<p>Center support</p>	<p>Fixed support</p>	<p>H.D. Rackarm</p>	<p>H.D. cross support tube 50x40x3</p>
<p>Double supports</p>	<p>Fixed blind</p>	<p>H.D. Rackarm</p>	<p>Cross angle 50x40x3</p>
<p>Motor side support</p>	<p>Fixed blind</p>	<p>H.D. Rackarm</p>	<p>H.D. cross support tube 50x40x3</p>

horiso
TYPE: Supports **date:** 21-12-08
description: Various types supports/rackarms
DWG nr: 09.100.01

TRIANGLE (EXAMPLE)

horiso™

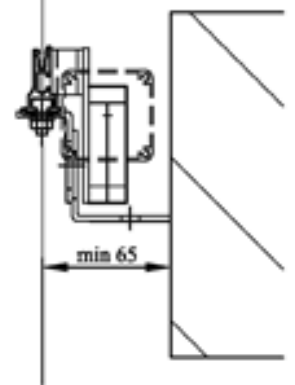
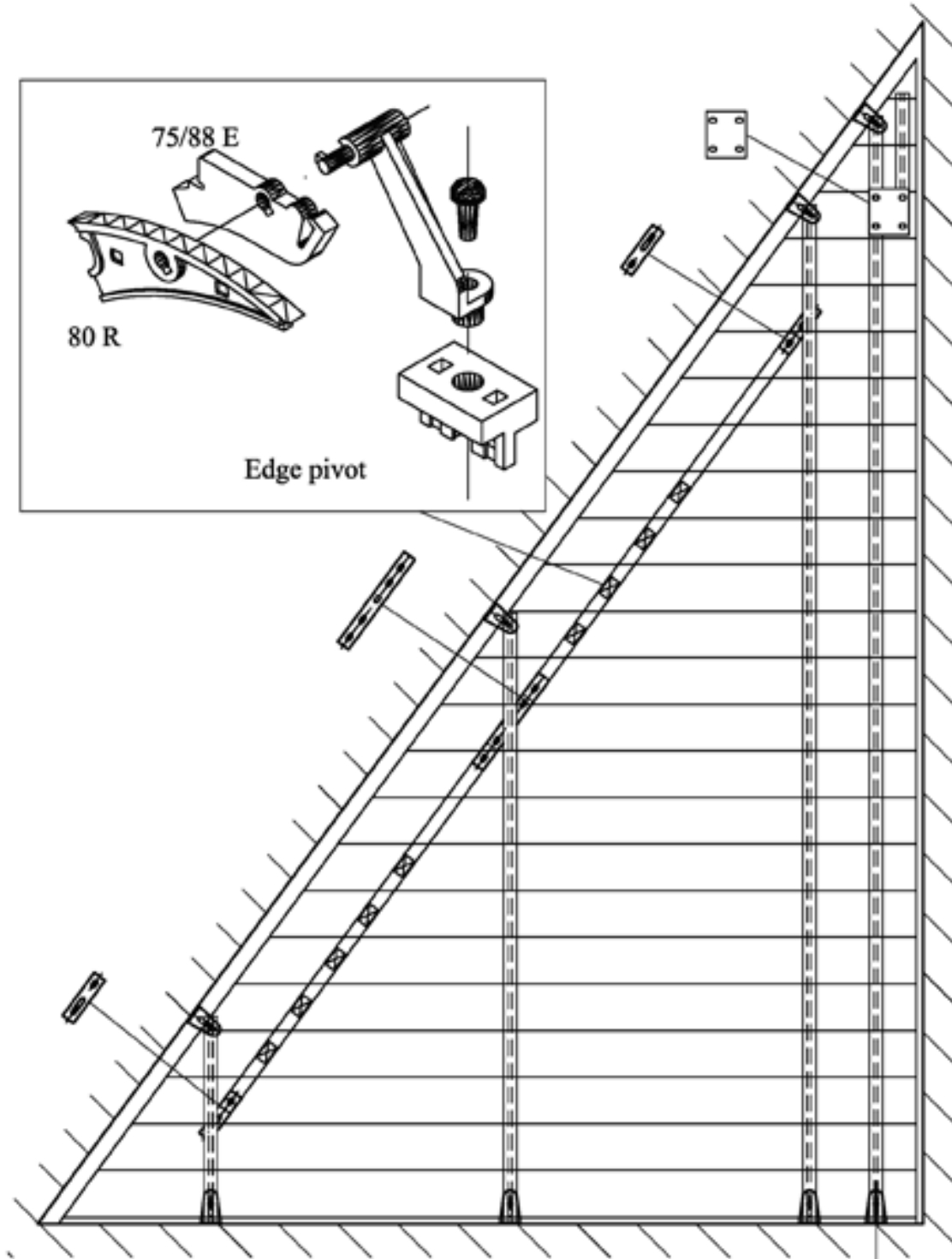
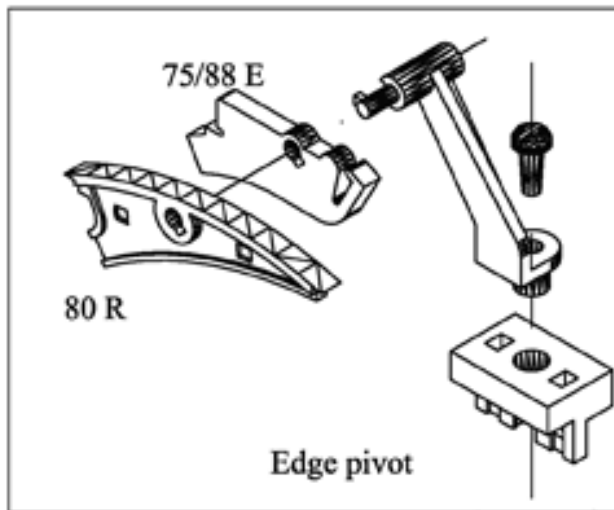

CIRCLE BLIND (EXAMPLE)

horiso™

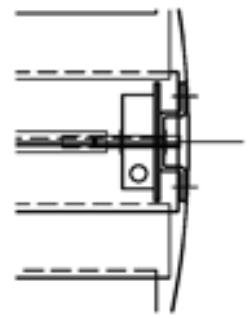

gearbox

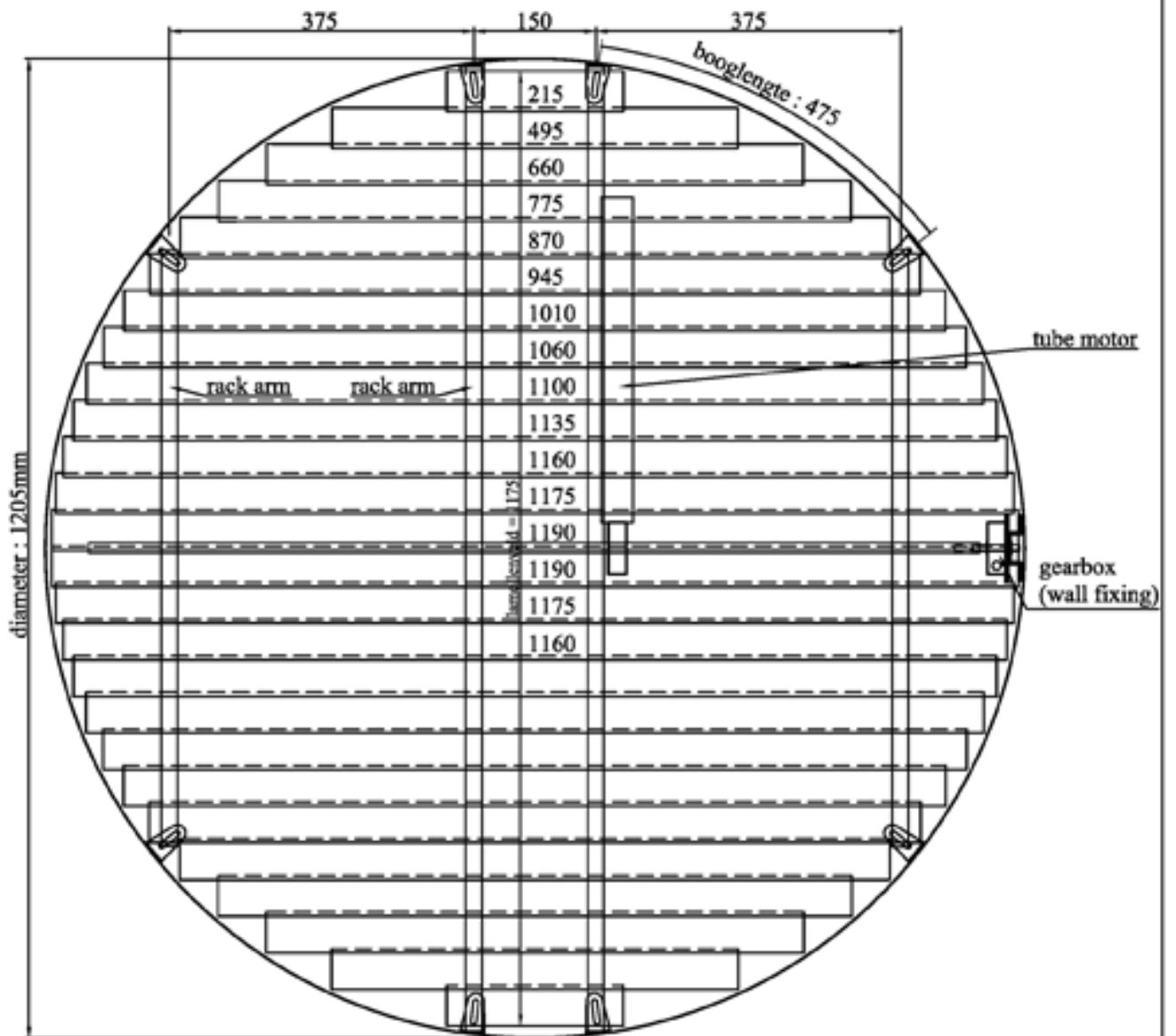

TRAPEZIUM (EXAMPLE)

horiso™

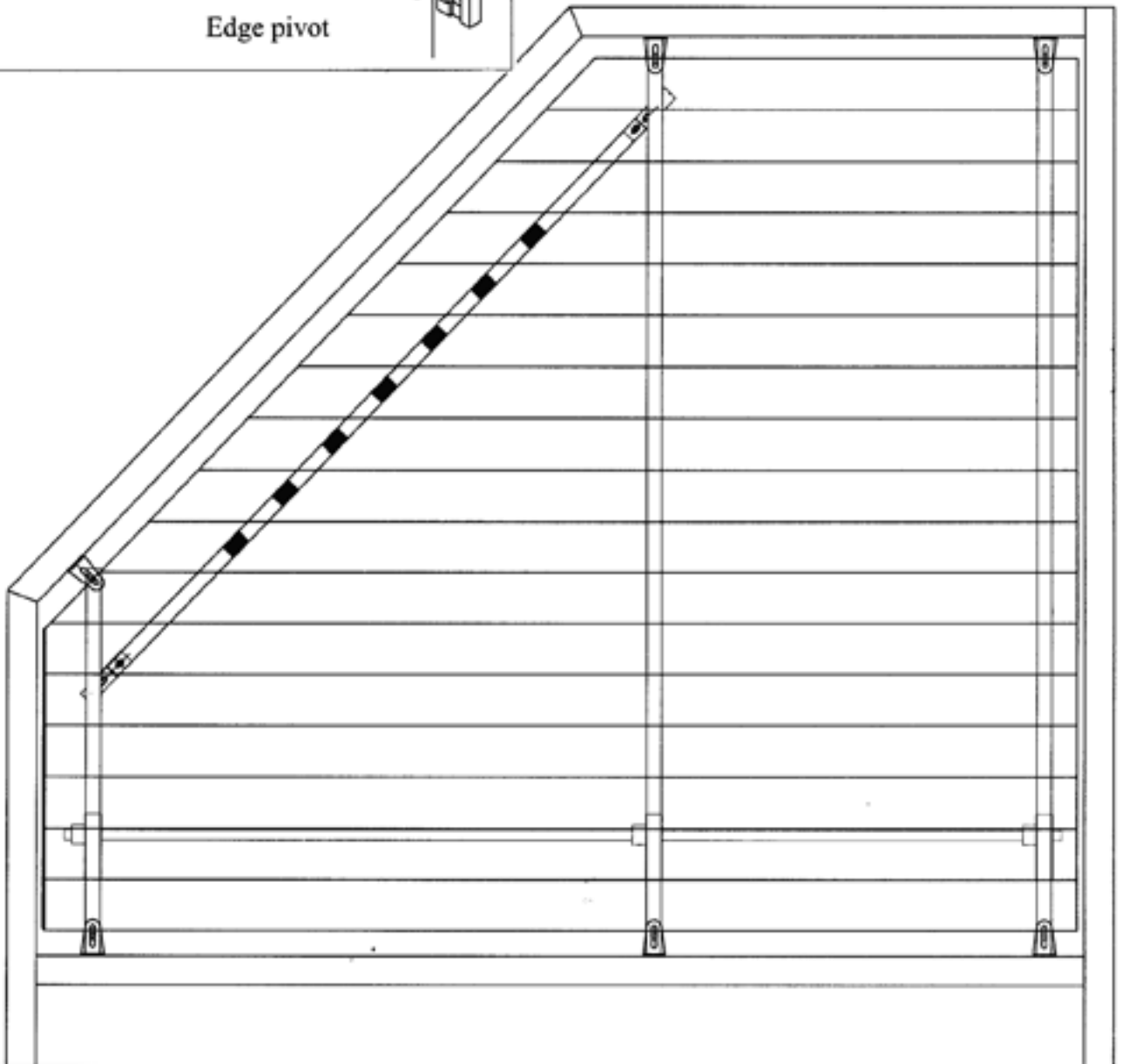
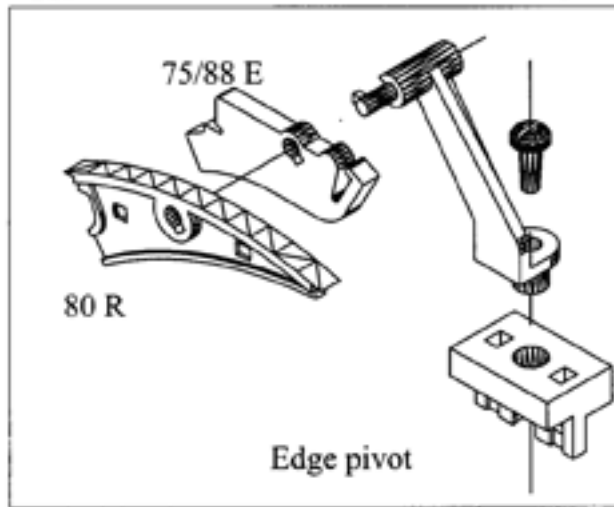

TRIANGLE (EXAMPLE)

horiso™

(RIGHT ISOSCELES)

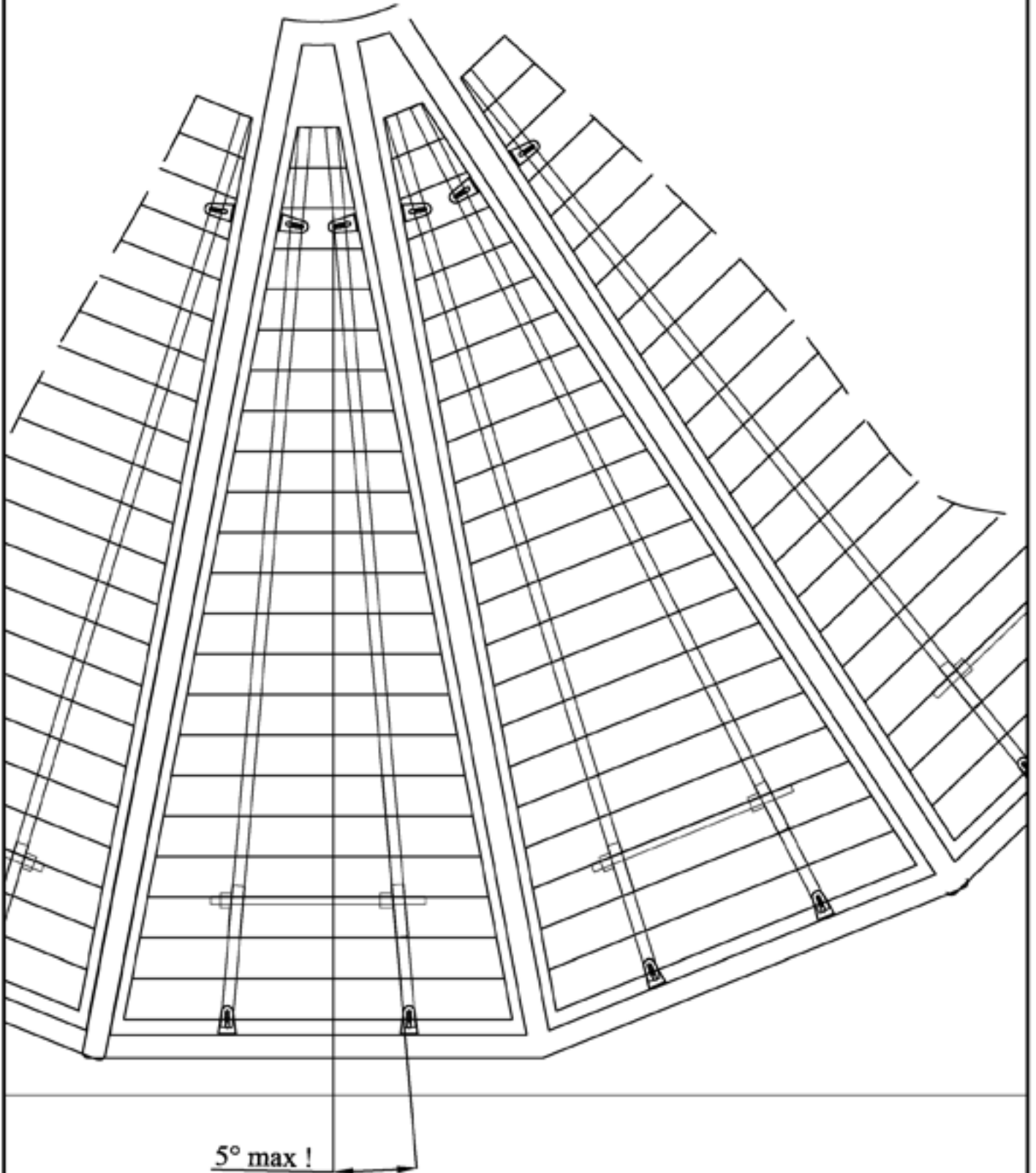

ARCHED (EXAMPLE)

horiso™

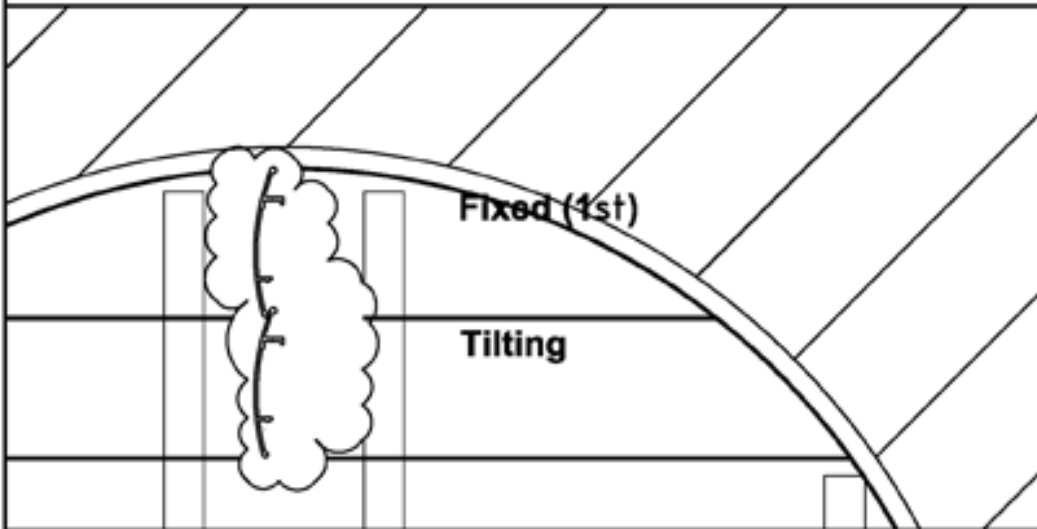

75E
88E
145E
Louvres
cut to
shape

option:
gearbox
&
handle

option:
motor

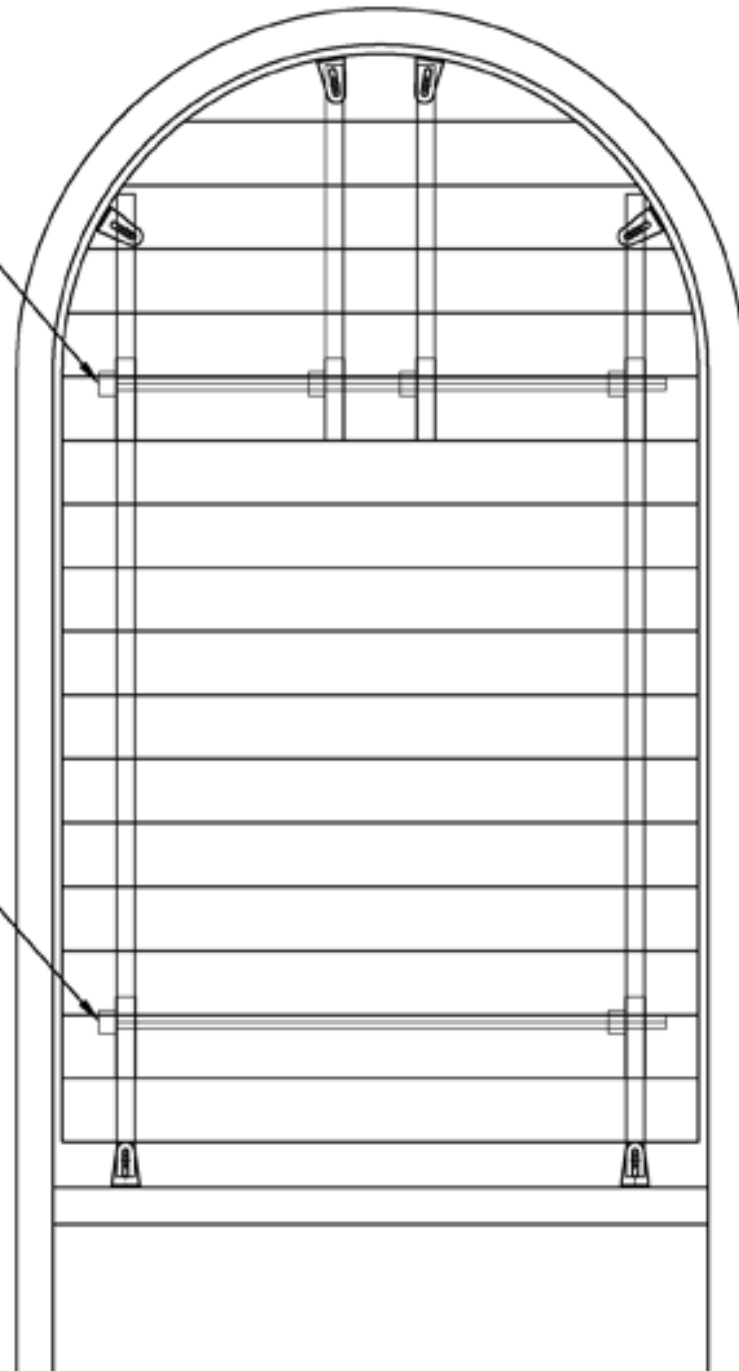

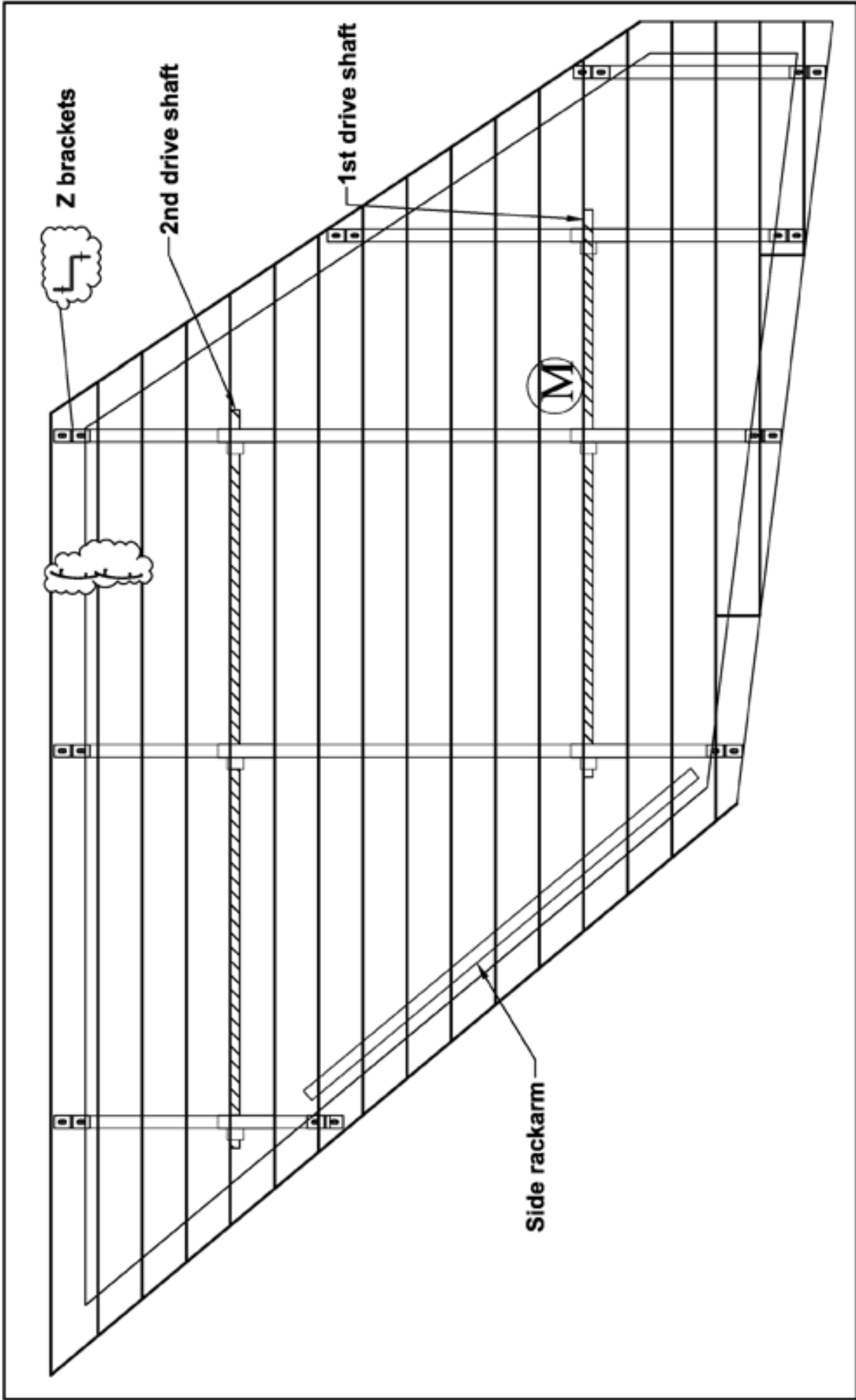





ASSYMETRIC WINDOWS (EXAMPLE)
 TANDEM RACKARM SYSTEM

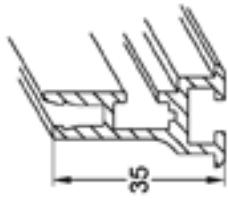
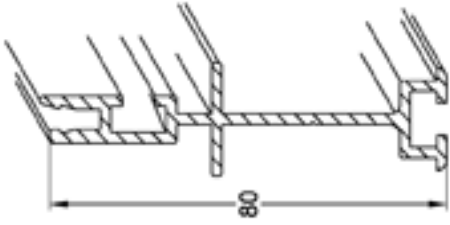

Summary of horiso™ aluminium extruded profiles

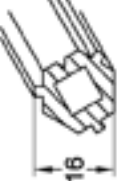
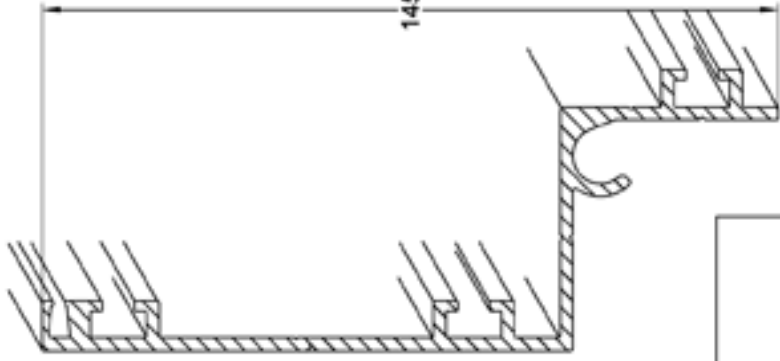
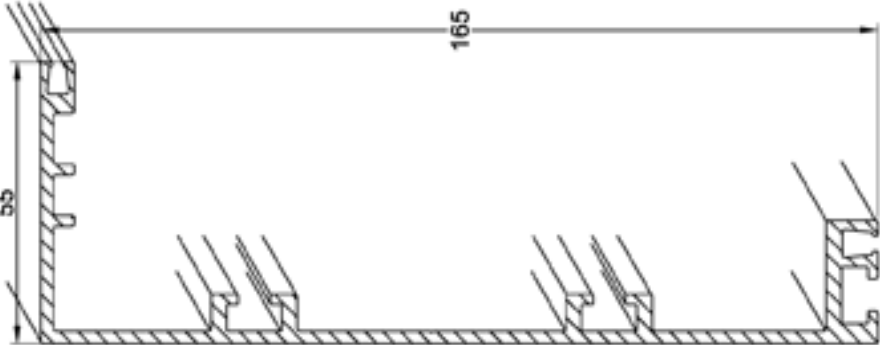
S - series

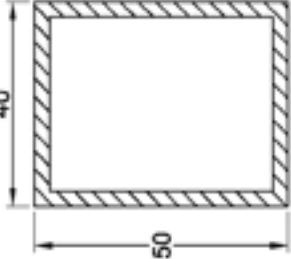
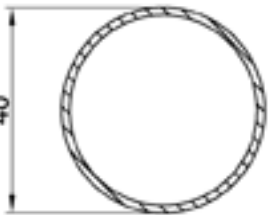
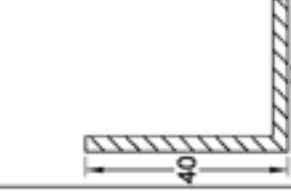
						
<p>58 050 standard rackarm</p>	<p>58 020 Heavy Duty rackarm</p>	<p>58 153 ST.operating strip</p>	<p>58 152 coat strip</p>	<p>58 060 drive shaft</p>	<p>80 145 Z - facia</p>	<p>80 165 universal facia</p>
<p>00 075 louver 75E</p>	<p>00 088 louver 88E</p>					
<p>58 072 motor hood</p>	<p>58 040 motor tube</p>	<p>00 504 cross bar</p>	<p>00 403 cross angle</p>	<p>80 145 Z - facia</p>	<p>80 165 universal facia</p>	<p>80 165 universal facia</p>
<p>horiso™ TYPE: Profiles description : S series 1:1 date : 2009 DWG nr : D.10.010.01</p>						<p>horiso - 22 Myrtle Street Marrickville NSW 2204 Australia Website : www.horiso.com E-mail : info@horiso.com Tel : (61 2) 8755 4500 Fax : (61 2) 8755 4555</p>

Summary of horiso™ aluminium extruded profiles

C - series 145E

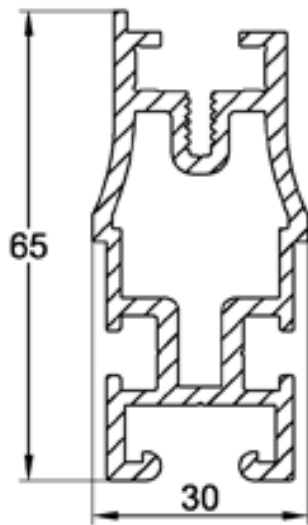

14 065
rackarm 65

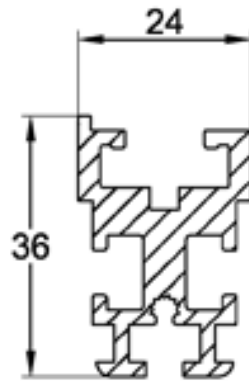

14 036
rackarm 36

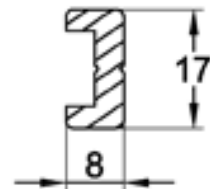

14 016
operating U

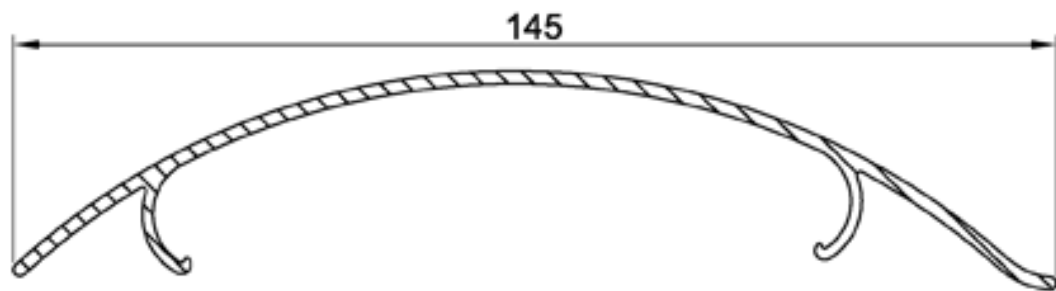

14 145
louver 145E

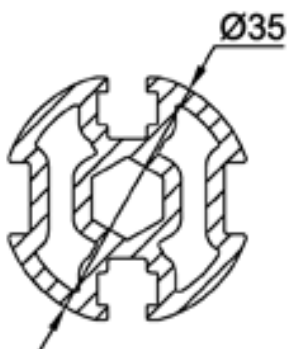

14 035
drive tube 35

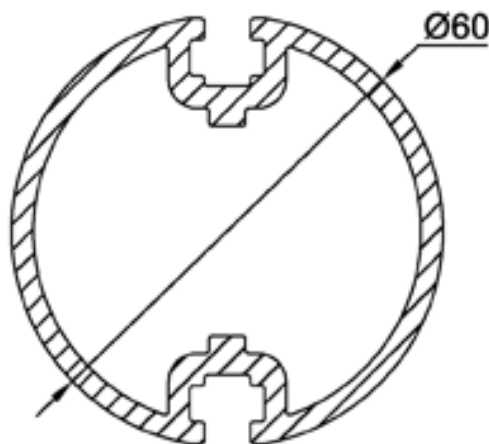

14 060
couple drive tube

horiso™	1:1
TYPE: PROFILES	date :
description :	2009
145 series	
DWG nr :	D. 10. 020. 01

horiso - 22 Myrtle Street Marrickville NSW 2204 Australia

www.horiso.com E-mail : info@horiso.com Tel : (61 2) 8755 4500 Fax : (61 2) 8755 4555

Summary of horiso™ aluminium extruded profiles

C - series 100C

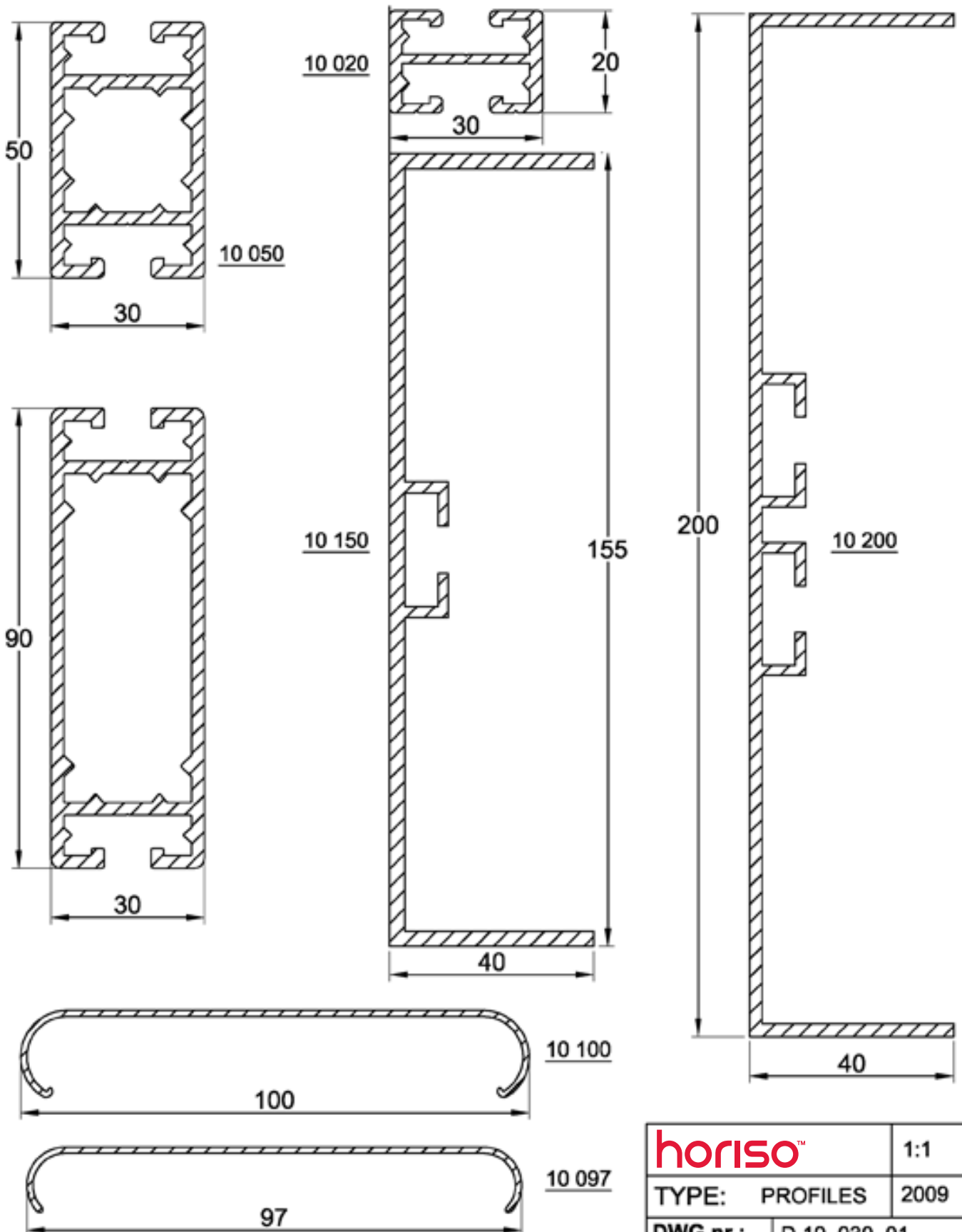

horiso™		1:1
TYPE:	PROFILES	2009
DWG nr :	D 10. 030. 01	

horiso - 22 Myrtle Street Marrickville NSW 2204 Australia

www.horiso.com E-mail : info@horiso.com Tel : (61 2) 8755 4500 Fax : (61 2) 8755 4555

Summary of horiso™ aluminium extruded profiles

S - series

PROJECT APPLICATION ONLY

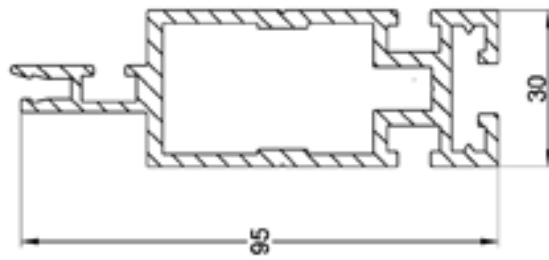

Box Rack - arm S - series

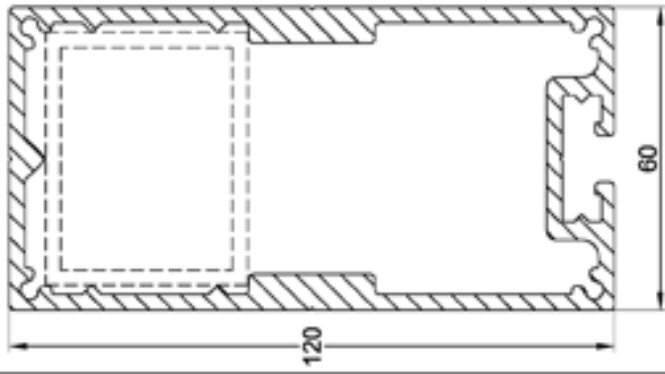

Tube rafter 60 x 120 C - series

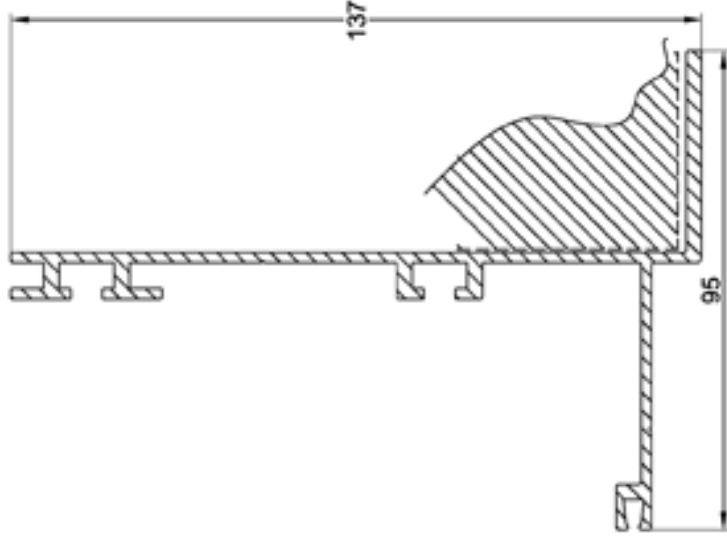

Facia (ceiling) S - series

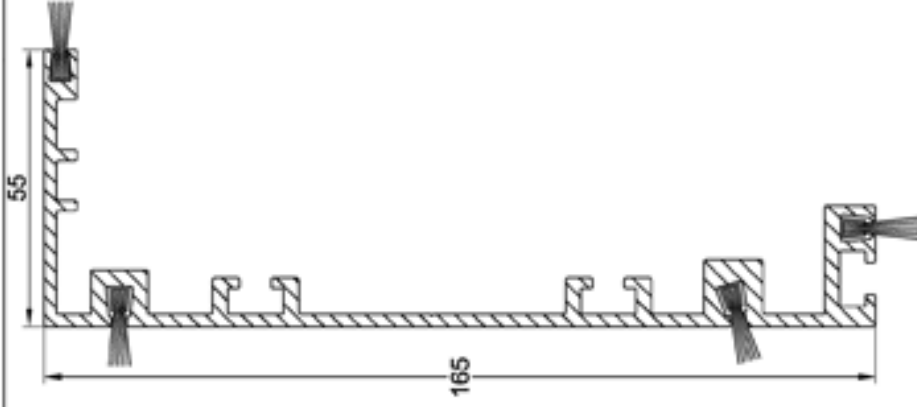

Facia (brushes) S - series

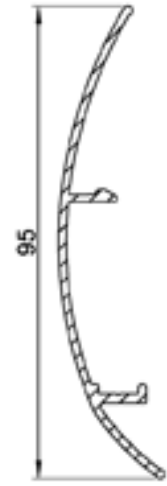

Louver 95 mm S - series

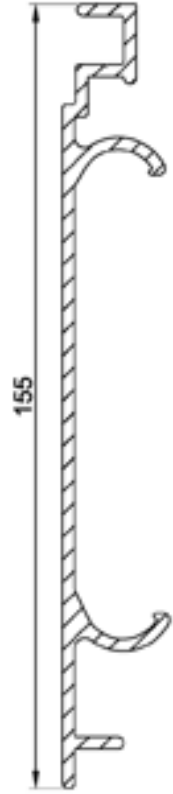

Louver 155 mm C - series

horiso™

TYPE: Profiles

description :

Project

Application

DWG nr : D.10.040.01

1:1

date :

horiso - 22 Myrtle Street Marrickville NSW 2204 Australia Website : www.horiso.com E-mail : info@horiso.com Tel : (61 2) 8755 4500 Fax : (61 2) 8755 4555